

Scharnierzijde UNI-JET S Draaival bestlag		Zonder bestlagroef	Met bestlagroef
Schaararm			
280 - 500		6-32970-18-L/R-1	
501 - 750		6-32971-18-L/R-1	
751 - 1200		6-32972-18-L/R-1	
1201 - 1600		6-32973-18-L/R-1	
Schaarlager met pen			
		6-31636-18-0-1	
Speun raamdeel		6-30687-18-R/L-1	6-31521-18-R/L-1
Speun kozijndeel			6-30316-18-L/R-1

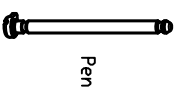

Scharnier raamdeel  
Zonder bestlagroef

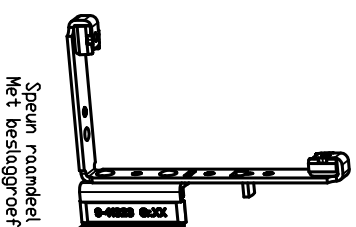
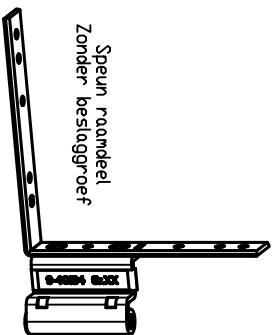

Speun raamdeel  
Met bestlagroef

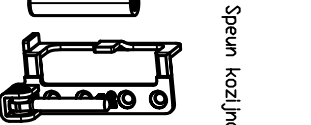

Speun kozijndeel

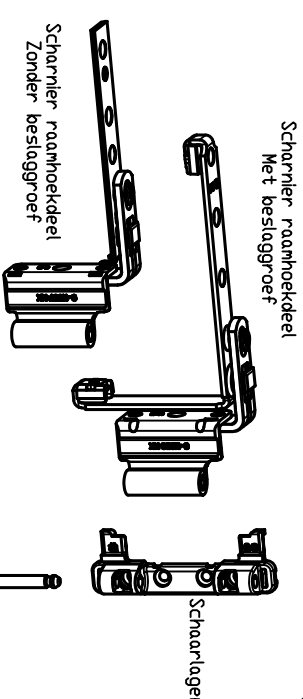

Scharnier raamhoekdeel  
Met bestlagroef

Scharnierzijde UNI-JET S Draaivaambestlag		Met bestlagroef	Zonder bestlagroef
Scharnier raamhoekdeel			
		6-31852-18-0-1	6-32633-18-0-1
Schaarlager met pen			
		6-31636-18-0-1	
Speun raamdeel		6-31521-18-R/L-1	6-30687-18-R/L-0-1
Speun kozijndeel			6-30316-18-L/R-1
Scharnier raamdeel		6-31854-18-0-1	6-32635-18-0-1
Schaarlager met pen			6-31636-18-0-1

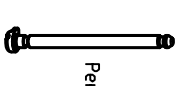

Scharnier raamdeel  
Met bestlagroef



Pen

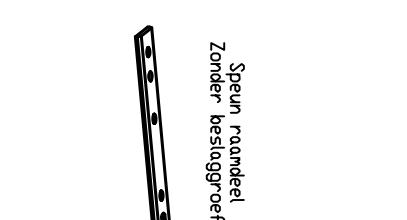

Speun raamdeel  
Zonder bestlagroef

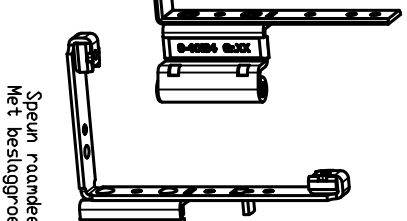

Speun raamdeel  
Met bestlagroef

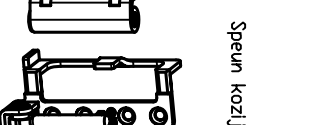

Speun kozijndeel

Valraamscharnier  
Met bestlagroef  
6-31847-18-0-1



Valraamscharnier  
Zonder bestlagroef  
6-32637-18-0-1



Schaarlager

Afdekkap  
Speun raamdeel  
9-37725-00-R/L-Kleur

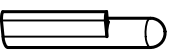

Afdekkap  
Speun kozijndeel  
9-42683-00-R/L-Kleur



Afdekkap  
Schaararm  
9-41654-00-0-Kleur



Afdekkap  
Schaararm  
9-41695-00-0-Kleur



Vaistrip  
1000mm  
8-00815



UNI-JET S Scharnierzijde Draaival  
UNI-JET S Scharnierzijde draai  
UNI-JET S Scharnierzijde val  
max. Raamgewicht 130kg  
Altijd productinformatie uit  
bestelcatalogus raadplegen

Bestelgegevens  
Raamspanningsbreedte RSB  
Raamspanningshoogte RSH  
Wensdelen  
Met of zonder bestlagroeffrezing  
Draairichting DIN links of DIN rechts

Deze tekening is een op onze  
ervaring berustend vrijblijvend  
uitvoeringsvoorstel, aan wiens gebruik  
geen rechten ontleend kunnen worden.

Benoeming  
Scharnierzijde UNI-JET S  
Draaivalbestlag / Draaivaambestlag / Valraambestlag

GU  
Gul-Hedeland B.V.  
Eindhoven  
Tel: 040-2121325  
www.gul.nl

copy rights  
reserved

Sein	Scale	Scale
check	---	---
check	Sp	%
swit	Be-03-2007	To
Replacement for	---	---

Drawing No.  
HL 00552  
Modification 11

S

2